

2

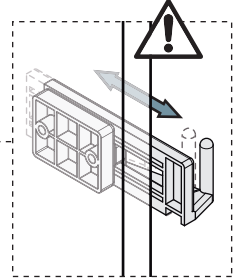

3

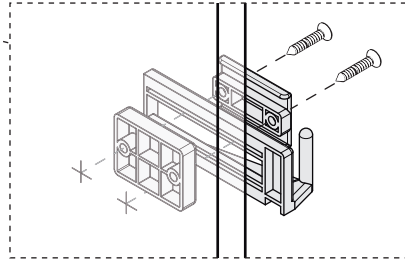
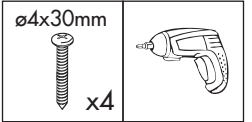
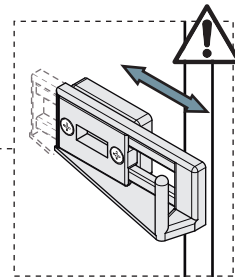
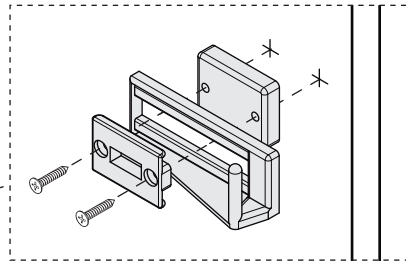
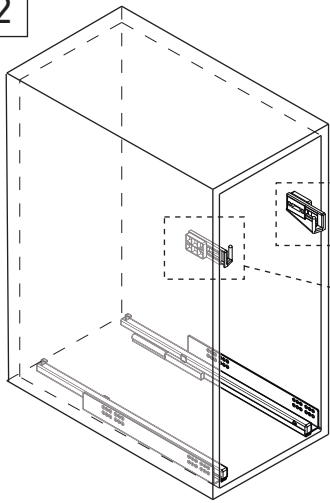
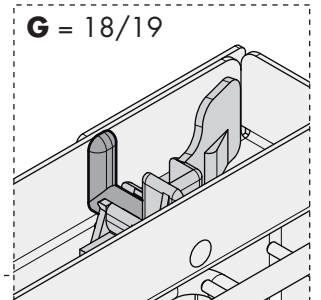
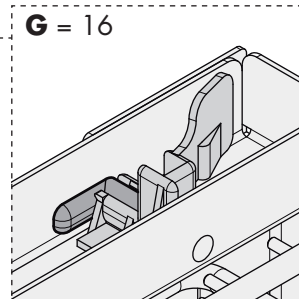
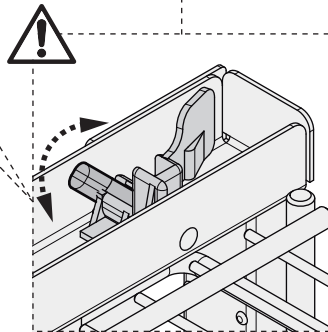
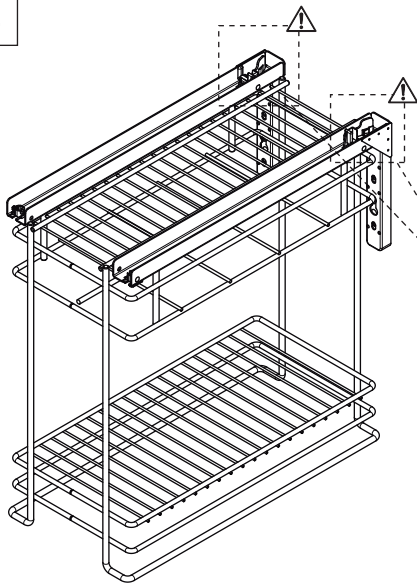

Unidades en milímetros | Units in millimeters | Unités en millimètres

4

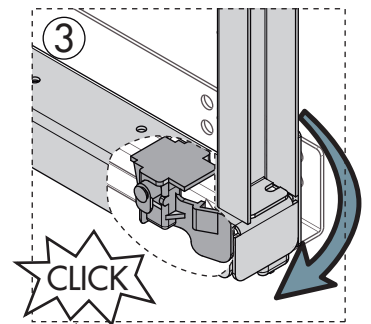
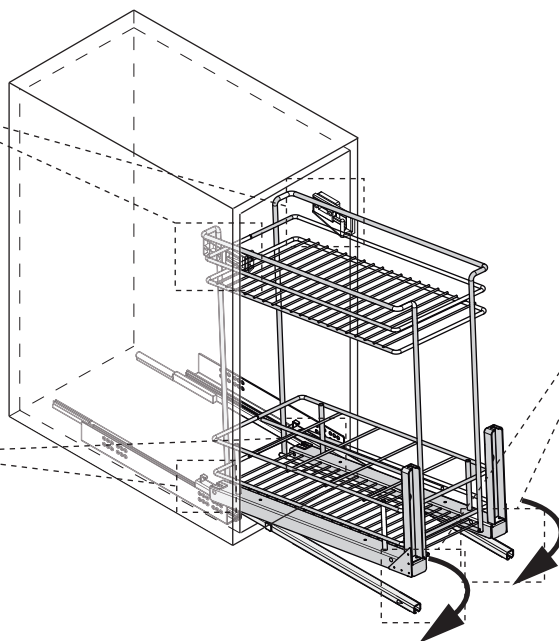
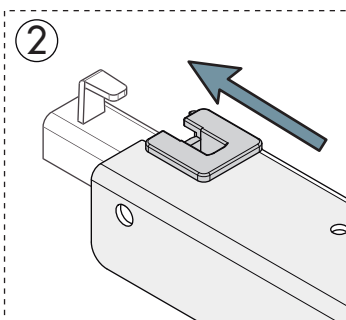
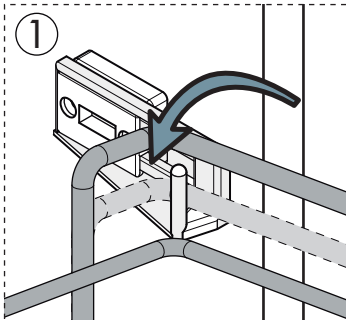

5

ø4x16mm

x8

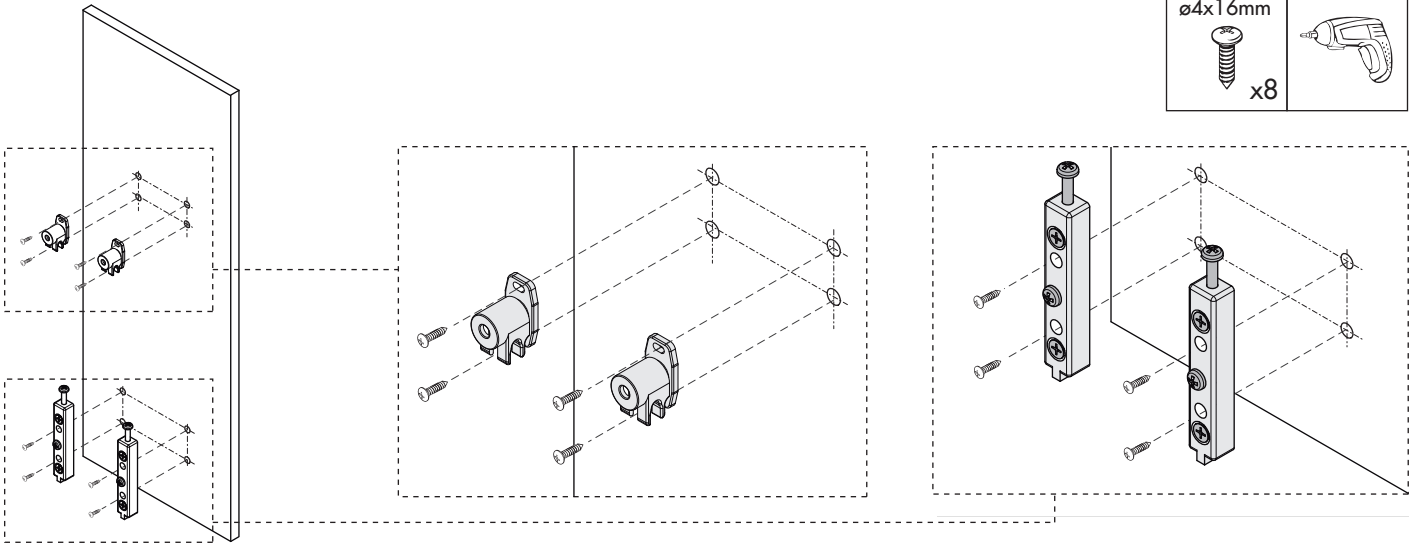

6

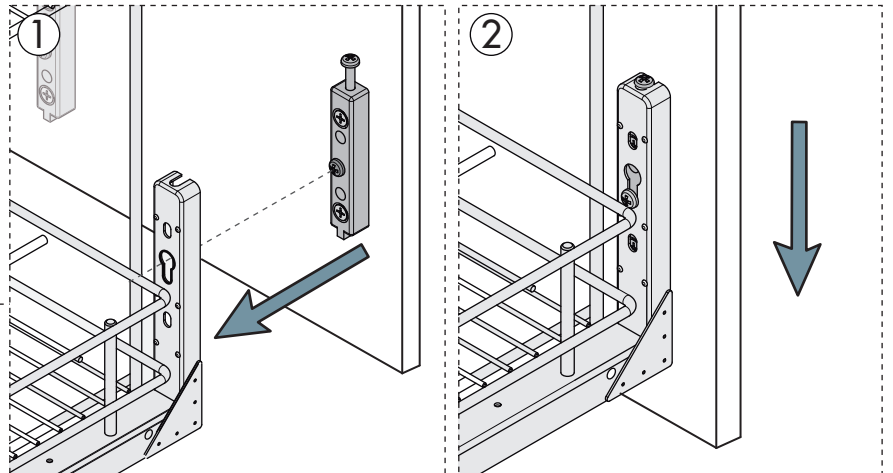
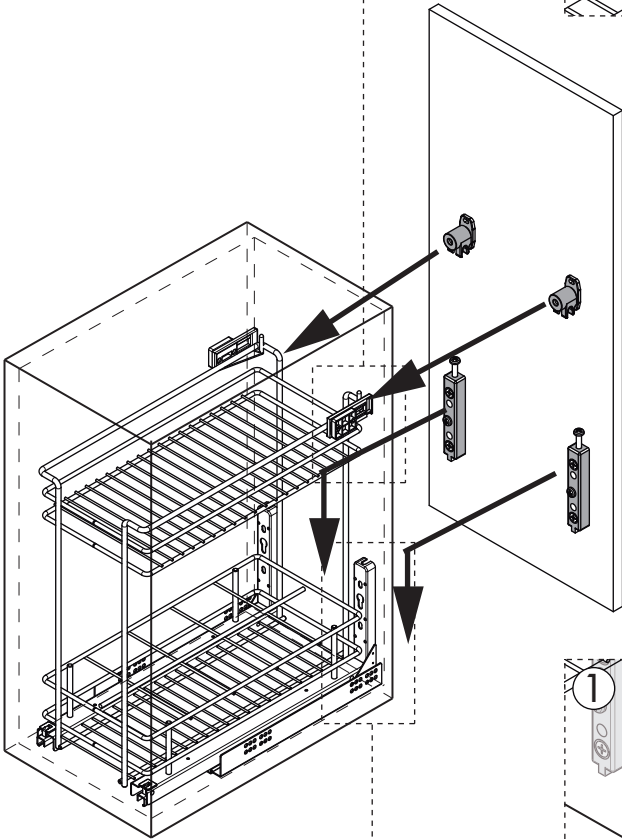
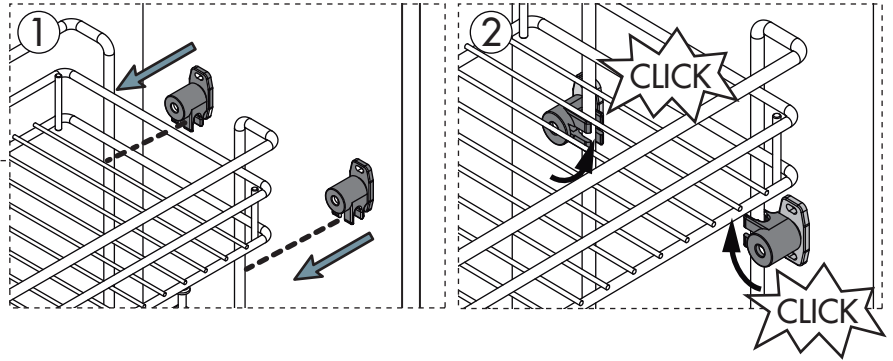

7

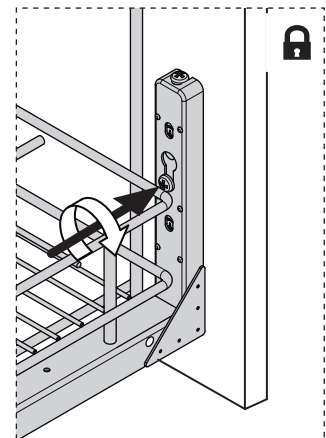
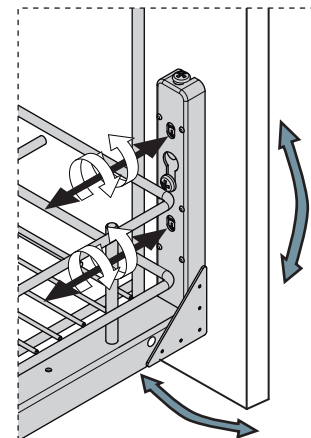
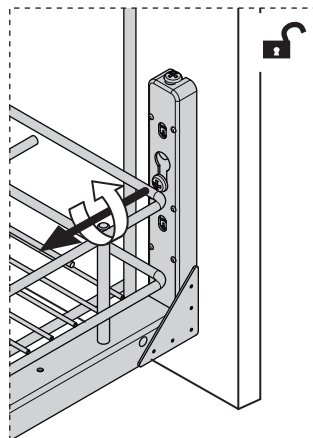
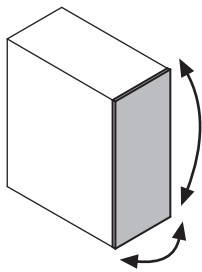
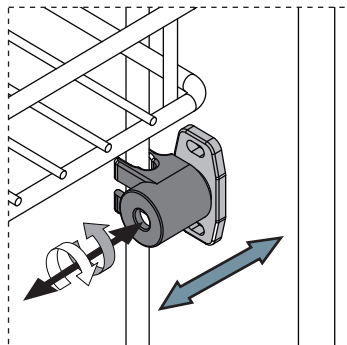
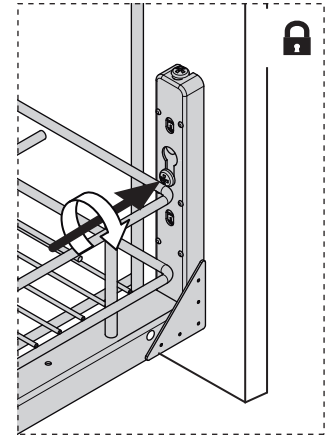
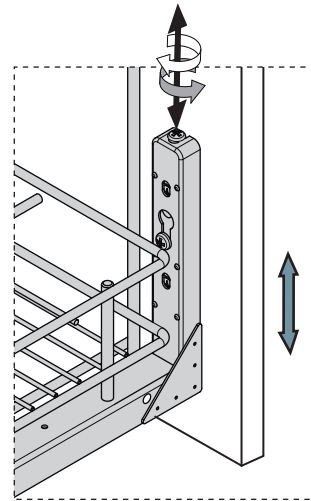
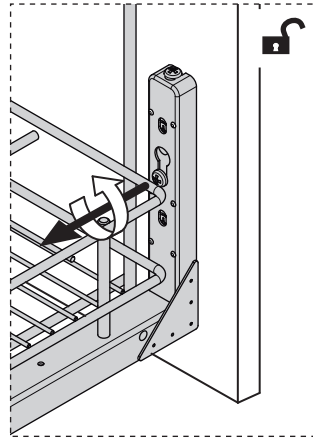
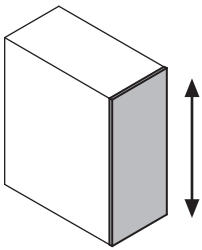
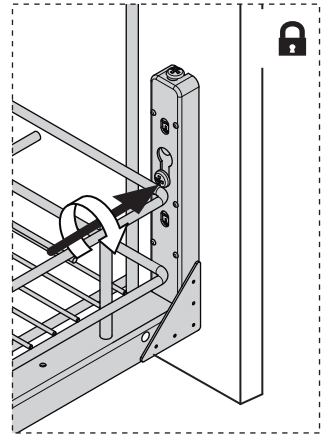
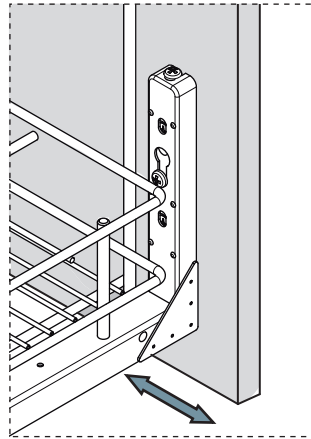
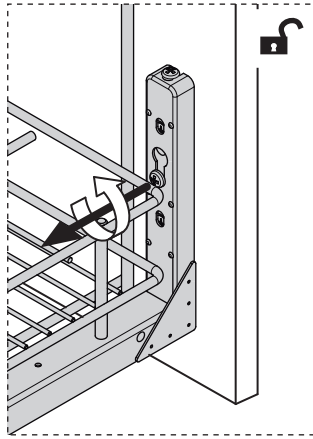
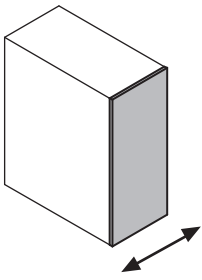

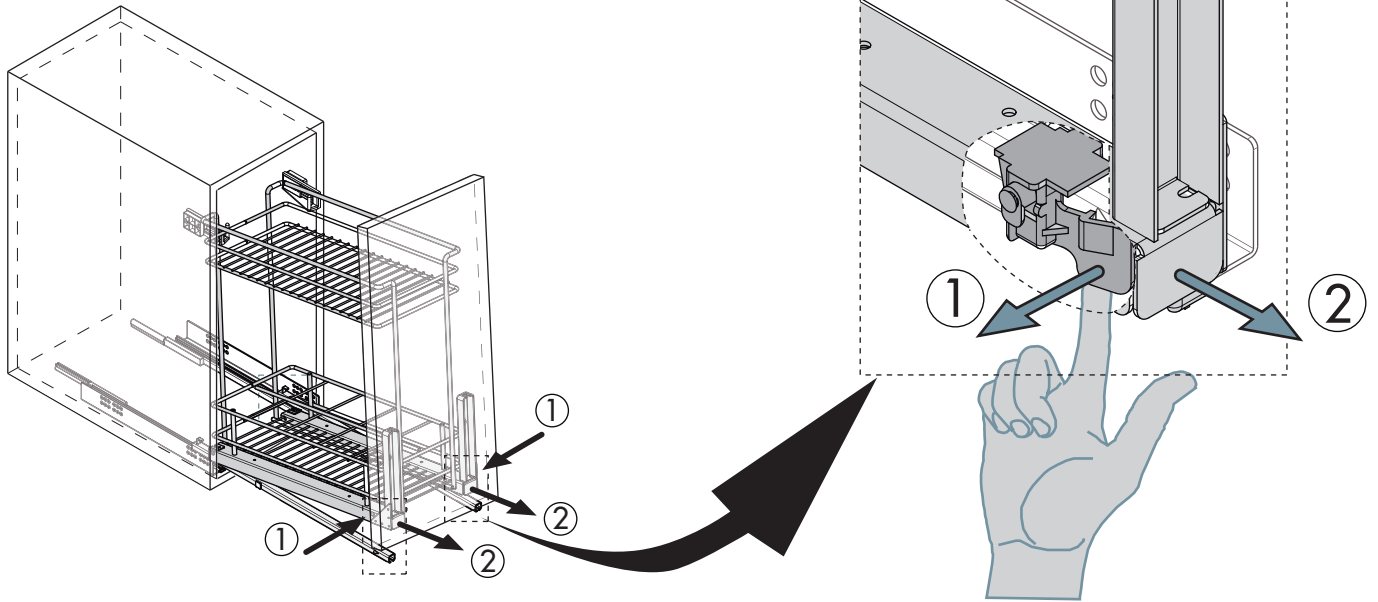

Accesorios opcionales | Optional accessories | Accessoires optionnels

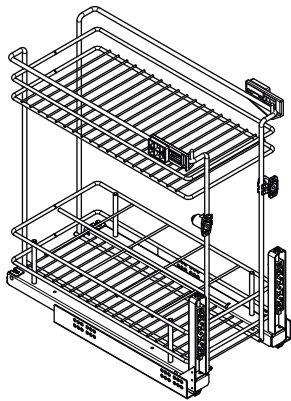

+

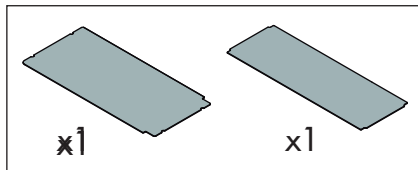

=

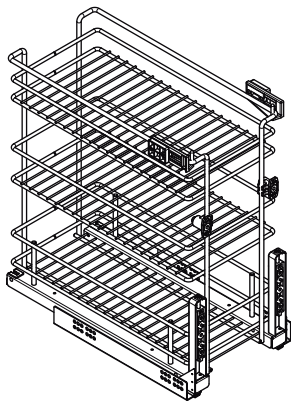
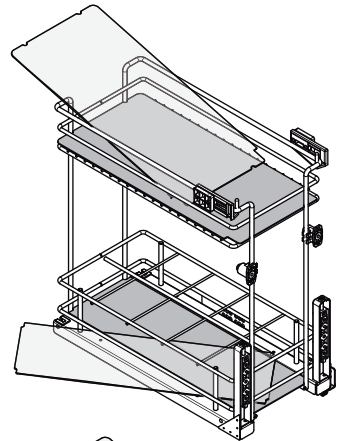

+

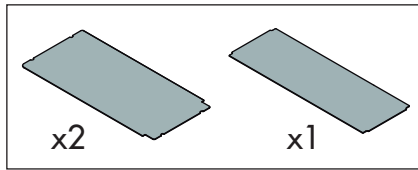

=

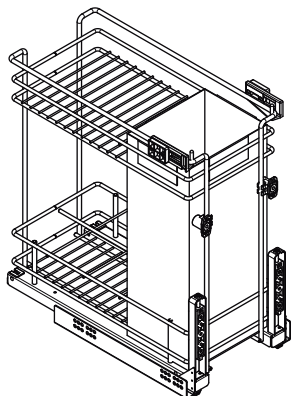
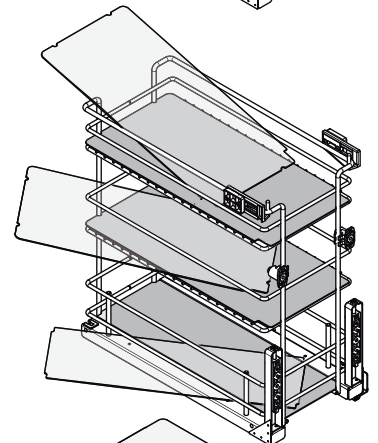

+

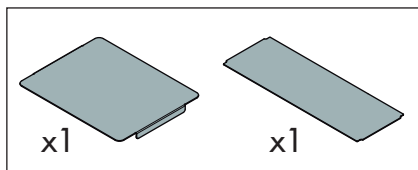

=

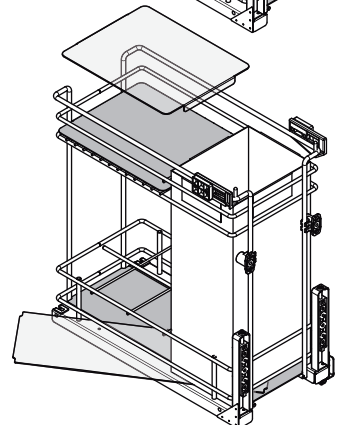

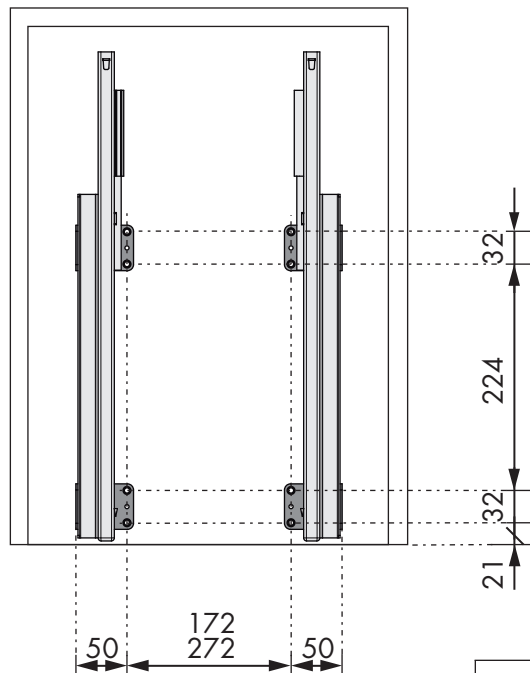
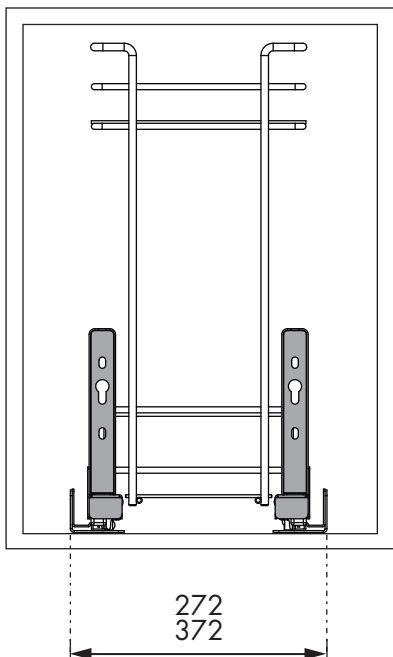
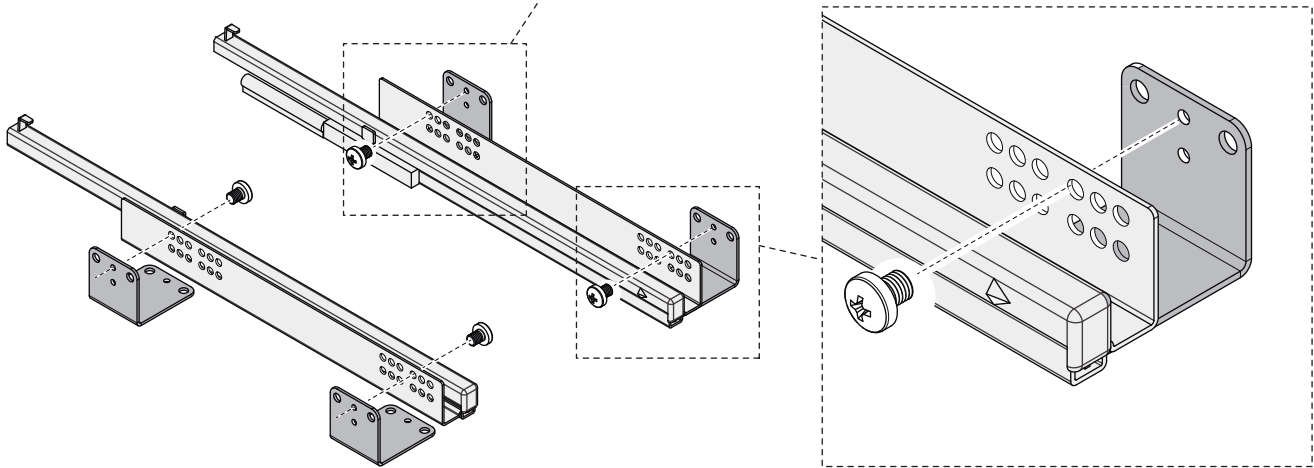
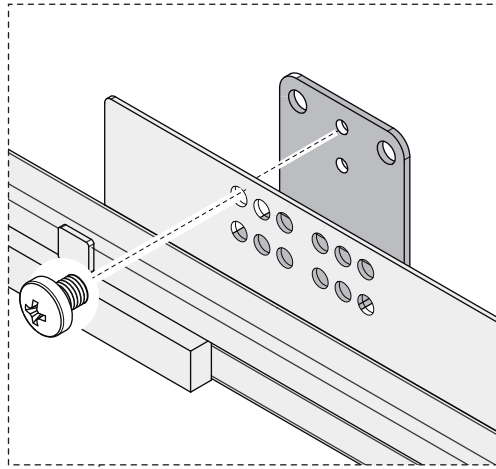
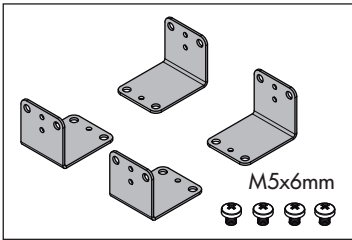

Unidades en milímetros | Units in millimeters | Unités en millimètres



IN00298.11 7/7